

## FORME DISPONIBILI

Available Shapes

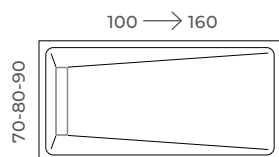

## ALTEZZA

Height

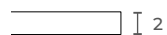

2 cm senza bordo  
2 cm without edge

## INSTALLAZIONE

Installation



Sopra pavimento  
Above floor



Filo pavimento  
Flush with floor

## COPRI PILETTA

Drain Cover

Disponibile solo materica in tinta  
Available only in matching textured finish

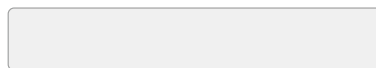

## MATERIALE

Material



## FINITURA SUPERFICIALE

Surface Finish

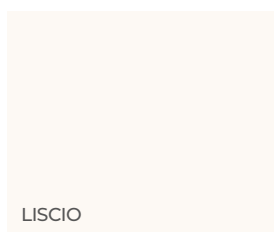

## COLORAZIONI

Colors

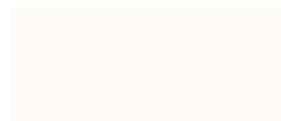

## PIETRE

Stones

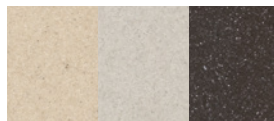

**SCARICO LATERALE**  
Lateral Drain

Disponibile in finitura Liscio  
Available in Liscio finish

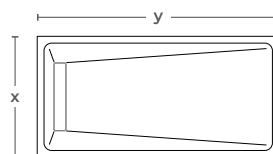

cm	x	70		80		90	
		LISCIO		LISCIO		LISCIO	
		Bianco	Grit Stone	Bianco	Grit Stone	Bianco	Grit Stone
100	y	MER0001	MER0013	MER0005	MER0017	MER0009	MER0021
120		MER0002	MER0014	MER0006	MER0018	MER0010	MER0022
140		MER0003	MER0015	MER0007	MER0019	MER0011	MER0023
160		MER0004	MER0016	MER0008	MER0020	MER0012	MER0024



Scarica i disegni tecnici + schema taglio  
in cantiere di tutti i formati disponibili  
*Download the technical drawings + cutting scheme  
on-site for all available formats.*

## INFORMAZIONI TECNICHE

### Technical Information

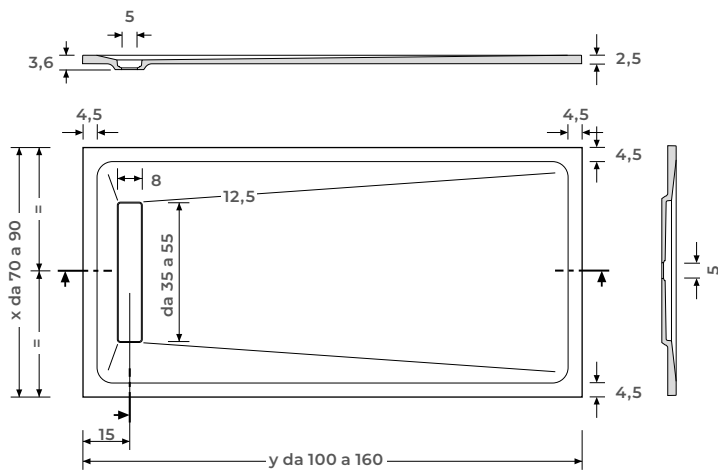

SCARICO LATERALE  
Lateral Drain

## COPRI PILETTA

### Drain Cover

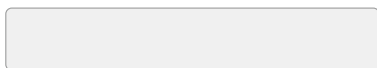

Disponibile solo materica in tinta con il piatto  
*Available only in matching textured finish with the tray*

**INCLUSA**  
*included*  
WGR0018

## PILETTE DI SCARICO

### Drain Outlet



Piletta a scarico orizzontale D.50 (deflusso 25 lt/min)  
*Horizontal drain D.50 (flow rate 25 l/min)*

**INCLUSA**  
*included*  
WPL0008

## TAGLI A MISURA

### Custom Cuts



Taglio longitudinale ogni 5mm in larghezza o lunghezza (su uno o più lati)

NOTA: il costo si intende per lato

*Longitudinal Cut Every 5mm in Width or Length (on one or more sides)*

*NOTE: The cost is per side*

MTLON01

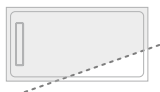

Taglio obliquo (su uno o più lati)

NOTA: il costo si intende per ogni taglio

*Diagonal Cut (on one or more sides)*

*NOTE: The cost is per cut*

MTOBL01



Taglio sagomato (su uno più angoli)

NOTA: il costo si intende per ogni taglio

*Shaped Cut (on one or more corners)*

*NOTE: The cost is per cut*

MTSAG01

Usfruendo delle soprascritte lavorazioni, il lato oggetto di modifica, verrà fornito con il bordo completamente ricostruito e texturizzato come la superficie del piatto doccia. Specificare la tipologia di taglio ed inviare disegno quotato. In base alla fattibilità il nostro ufficio commerciale si riserva l'accettazione dell'ordine.  
*By utilizing the above-mentioned modifications, the altered side will be provided with a fully reconstructed and textured edge, matching the surface of the shower tray. Please specify the type of cut and submit a detailed drawing with measurements. Based on feasibility, our sales office reserves the right to accept the order.*

## PERIMETRO OPZIONALE

### Optional Perimeter

NON REALIZZABILE

*Not Feasible*

## KIT DI RIPRISTINO

### Restoration kit



Kit per il ripristino di scheggiature.

Il kit comprende: catalizzatore, massa solid, scotch-brite, istruzioni

*Chip repair kit.*

*The kit includes: catalyst, massa solid, Scotch-Brite, instructions.*

WKT0003

Kit per il ripristino di graffi superficiali.

Il kit comprende: scotch-brite, istruzioni

*Surface scratch repair kit.*

*The kit includes: Scotch-Brite, instructions.*

WKT0004