

FORME DISPONIBILI

Available Shapes

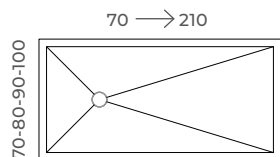

ALTEZZA

Height

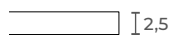

2,5 cm senza bordo
2,5 cm without edge

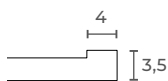

3,5 cm con bordo
3,5 cm with edge

INSTALLAZIONE

Installation



Sopra pavimento
Above floor



Filo pavimento
Flush with floor

COPRI PILETTA

Drain Cover

Disponibile solo materica in tinta
Available only in matching textured finish



MATERIALE

Material

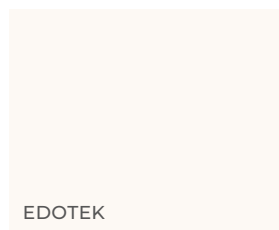

EDOTEK

FINITURA SUPERFICIALE

Surface Finish

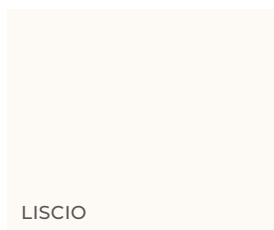

LISCIO

COLORAZIONI

Colors

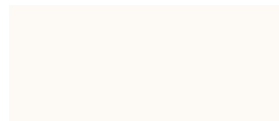

BIANCO

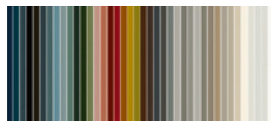

GAMMA COLORI EDONÉ
MAZZETTA n.51
(NO METAL/DUST)

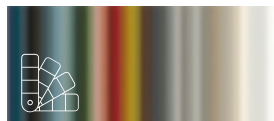

GAMMA RAL/NCS

SCARICO LATERALE Lateral Drain

Disponibile in finitura Liscio
Available in Liscio finish

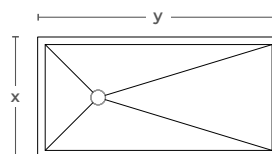

| cm | x | 70 | | 80 | | 90 | | 100 | |
|-----|---|---------|--------------|---------|--------------|---------|--------------|---------|--------------|
| | | LISCIO | | LISCIO | | LISCIO | | LISCIO | |
| | | Bianco | Colori Edoné | Bianco | Colori Edoné | Bianco | Colori Edoné | Bianco | Colori Edoné |
| 70 | | TER0001 | TER0067 | - | - | - | - | - | - |
| 80 | | TER0002 | TER0068 | TER0016 | TER0082 | - | - | - | - |
| 90 | | TER0003 | TER0069 | TER0017 | TER0083 | TER0030 | TER0096 | - | - |
| 100 | | TER0004 | TER0070 | TER0018 | TER0084 | TER0031 | TER0097 | TER0043 | TER0055 |
| 110 | | TER0005 | TER0071 | TER0019 | TER0085 | TER0032 | TER0098 | TER0044 | TER0056 |
| 120 | | TER0006 | TER0072 | TER0020 | TER0086 | TER0033 | TER0099 | TER0045 | TER0057 |
| 130 | | TER0007 | TER0073 | TER0021 | TER0087 | TER0034 | TER0100 | TER0046 | TER0058 |
| 140 | | TER0008 | TER0074 | TER0022 | TER0088 | TER0035 | TER0101 | TER0047 | TER0059 |
| 150 | | TER0009 | TER0075 | TER0023 | TER0089 | TER0036 | TER0102 | TER0048 | TER0060 |
| 160 | | TER0010 | TER0076 | TER0024 | TER0090 | TER0037 | TER0103 | TER0049 | TER0061 |
| 170 | | TER0011 | TER0077 | TER0025 | TER0091 | TER0038 | TER0104 | TER0050 | TER0062 |
| 180 | | TER0012 | TER0078 | TER0026 | TER0092 | TER0039 | TER0105 | TER0051 | TER0063 |
| 190 | | TER0013 | TER0079 | TER0027 | TER0093 | TER0040 | TER0106 | TER0052 | TER0064 |
| 200 | | TER0014 | TER0080 | TER0028 | TER0094 | TER0041 | TER0107 | TER0053 | TER0065 |
| 210 | | TER0015 | TER0081 | TER0029 | TER0095 | TER0042 | TER0108 | TER0054 | TER0066 |

MCSPE01
 Colori RAL/NCS **+10%** dal prezzo di listino Colori Edoné indicato
 RAL/NCS Colors **+10%** from the list price of the indicated Edoné's colors.



Scarica i disegni tecnici + schema taglio
 in cantiere di tutti i formati disponibili
 Download the technical drawings + cutting scheme
 on-site for all available formats.

INFORMAZIONI TECNICHE

Technical Information

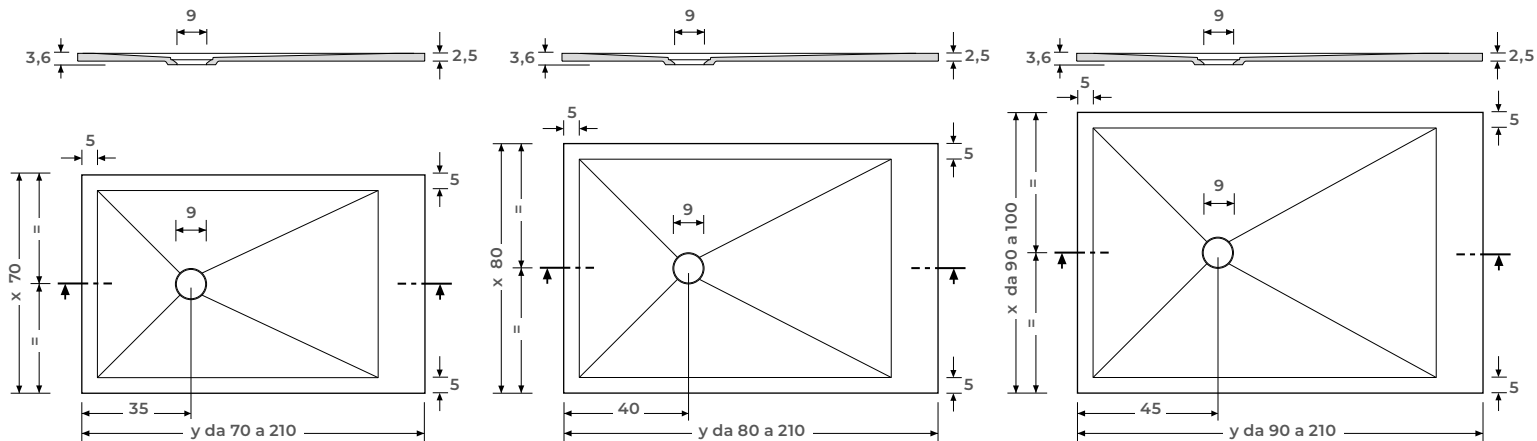

SCARICO LATERALE
Lateral Drain

SCARICO LATERALE
Lateral Drain

SCARICO LATERALE
Lateral Drain

COPRI PILETTA

Drain Cover



Disponibile solo materica in tinta con il piatto
Available only in matching textured finish with the tray

INCLUSA
included
WGR0014

PILETTE DI SCARICO

Drain Outlet



Piletta a scarico orizzontale rettangolare (deflusso 10 lt/min)
Rectangular horizontal drain (flow rate 10 l/min)

INCLUSA
included
WP0004

TAGLI A MISURA

Custom Cuts



Taglio longitudinale ogni 5mm in larghezza o lunghezza (su uno o più lati)

NOTA: il costo si intende per lato

Longitudinal Cut Every 5mm in Width or Length (on one or more sides)

NOTE: The cost is per side

MTLON01

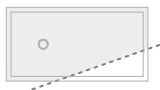

Taglio obliquo (su uno o più lati)

NOTA: il costo si intende per ogni taglio

Diagonal Cut (on one or more sides)

NOTE: The cost is per cut

MTOBL01



Taglio sagomato (su uno più angoli)

NOTA: il costo si intende per ogni taglio

Shaped Cut (on one or more corners)

NOTE: The cost is per cut

MTSAG01

Usfruendo delle soprascritte lavorazioni, il lato oggetto di modifica, verrà fornito con il bordo completamente ricostruito e texturizzato come la superficie del piatto doccia. Specificare la tipologia di taglio ed inviare disegno quotato. In base alla fattibilità il nostro ufficio commerciale si riserva l'accettazione dell'ordine.
By utilizing the above-mentioned modifications, the altered side will be provided with a fully reconstructed and textured edge, matching the surface of the shower tray. Please specify the type of cut and submit a detailed drawing with measurements. Based on feasibility, our sales office reserves the right to accept the order.

PERIMETRO OPZIONALE

Optional Perimeter

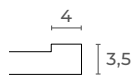

SCARICO LATERALE
Lateral Drain

Bordo nella stessa finitura del piatto doccia.

Realizzabile solo sui lati dritti (specificare quali)

Edge in the same finish as the shower tray.

Available only on straight sides (please specify which ones)

prezzo al cm/l
price per cm/l

MABOR01

KIT DI RIPRISTINO

Restoration kit



Kit per il ripristino di scheggiature.

Il kit comprende: catalizzatore, colore, scotch-brite, istruzioni

Chip repair kit.

The kit includes: catalyst, color, Scotch-Brite, instructions.

WKT0001

Kit per il ripristino di graffi superficiali.

Il kit comprende: boccetta colore, scotch-brite, istruzioni

Surface scratch repair kit.

The kit includes: color bottle, Scotch-Brite, instructions.

WKT0002