

## FORME DISPONIBILI

Available Shapes

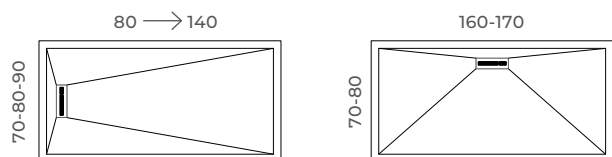

## ALTEZZA

Height

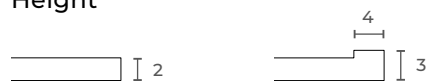

2 cm senza bordo  
2 cm without edge

3 cm con bordo  
3 cm with edge

## INSTALLAZIONE

Installation



Sopra pavimento  
Above floor



Filo pavimento  
Flush with floor

## GRIGLIA

Grid

Disponibile inox e in tinta  
Available in stainless steel and matching color



## MATERIALE

Material

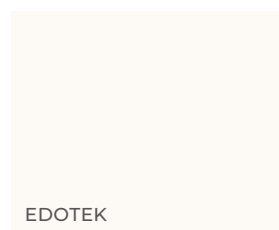

EDOTEK

## FINITURA SUPERFICIALE

Surface Finish



SPAZZOLATO

## COLORAZIONI

Colors

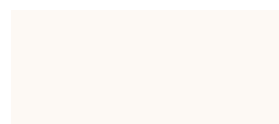

BIANCO

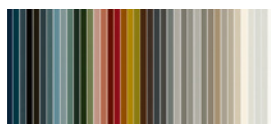

GAMMA COLORI EDONÉ  
MAZZETTA n.51  
(NO METAL/DUST)



GAMMA RAL/NCS

## SCARICO LATERALE Lateral Drain

Disponibile in finitura Spazzolato  
Available in Spazzolato finish

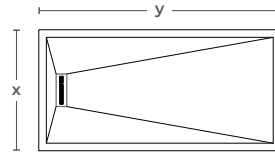

cm	x	70	80	90			
	y	Bianco	Colori Edoné	Bianco	Colori Edoné	Bianco	Colori Edoné
80		-	-	URA0005	URA0017	-	-
90		URA0001	URA0013	-	-	URA0009	URA0021
100		URA0002	URA0014	URA0006	URA0018	URA0010	URA0022
120		URA0003	URA0015	URA0007	URA0019	URA0011	URA0023
140		URA0004	URA0016	URA0008	URA0020	URA0012	URA0024

## SCARICO CENTRALE Central Drain

Disponibile in finitura Spazzolato  
Available in Spazzolato finish

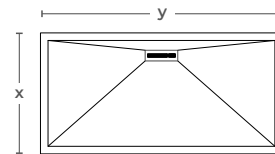

cm	x	70	80	90			
	y	Bianco	Colori Edoné	Bianco	Colori Edoné	Bianco	Colori Edoné
160		-	-	URA0026	URA0029	-	-
170		URA0025	URA0028	URA0027	URA0030	-	-

MCSPE01  
Colori RAL/NCS **+10%** dal prezzo di listino Colori Edoné indicato  
RAL/NCS Colors **+10%** from the list price of the indicated Edoné's colors.



Scarica i disegni tecnici + schema taglio  
in cantiere di tutti i formati disponibili

Download the technical drawings + cutting scheme  
on-site for all available formats.

## INFORMAZIONI TECNICHE

### Technical Information

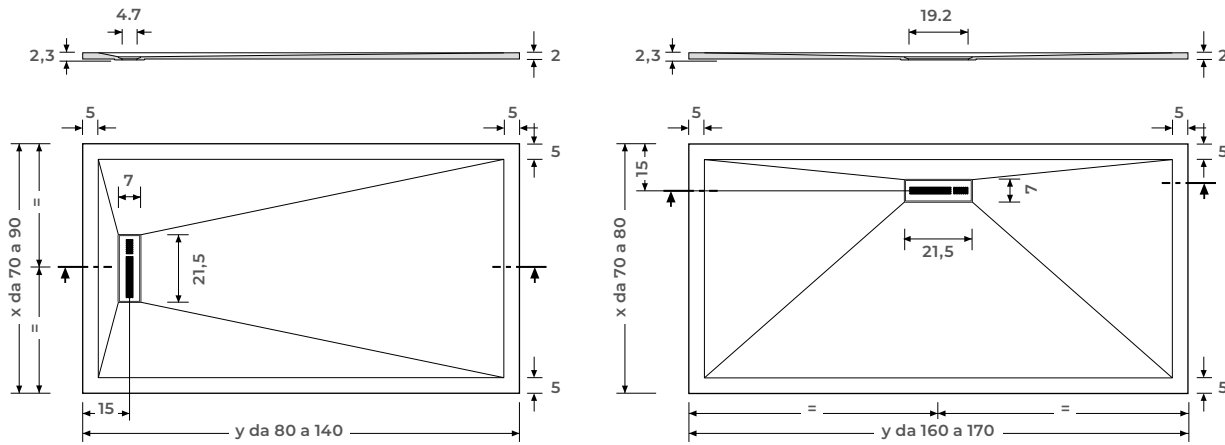

SCARICO LATERALE  
Lateral Drain

SCARICO CENTRALE  
Central Drain

## GRIGLIA

### Grid

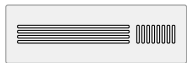

Griglia rettangolare  
Rectangular Grid

inox	Bianco	Colori Edoné	Colori NCS/RAL
<b>INCLUSA</b> <i>included</i> WGR0005	WGR0006	WGR0007	WGR0008

## PILETTA DI SCARICO

### Drain Outlet

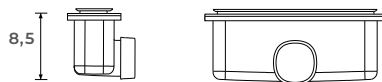

Piletta a scarico orizzontale rettangolare (deflusso 37 lt/min)  
Rectangular horizontal drain (flow rate 37 l/min)

**INCLUSA**  
*included*  
WPL0005

## TAGLI A MISURA

### Custom Cuts



Taglio longitudinale ogni 5mm in larghezza o lunghezza (su uno o più lati)

NOTA: il costo si intende per lato

*Longitudinal Cut Every 5mm in Width or Length (on one or more sides)*

*NOTE: The cost is per side*

MTL0M01

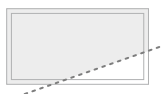

Taglio obliquo (su uno o più lati)

NOTA: il costo si intende per ogni taglio

*Diagonal Cut (on one or more sides)*

*NOTE: The cost is per cut*

MT0BL01



Taglio sagomato (su uno più angoli)

NOTA: il costo si intende per ogni taglio

*Shaped Cut (on one or more corners)*

*NOTE: The cost is per cut*

MTSAG01

Usfruendo delle soprascritte lavorazioni, il lato oggetto di modifica, verrà fornito con il bordo completamente ricostruito e texturizzato come la superficie del piatto doccia. Specificare la tipologia di taglio ed inviare disegno quotato. In base alla fattibilità il nostro ufficio commerciale si riserva l'accettazione dell'ordine.  
*By utilizing the above-mentioned modifications, the altered side will be provided with a fully reconstructed and textured edge, matching the surface of the shower tray. Please specify the type of cut and submit a detailed drawing with measurements. Based on feasibility, our sales office reserves the right to accept the order.*

## PERIMETRO OPZIONALE

### Optional Perimeter

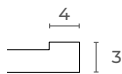

SCARICO LATERALE  
Lateral Drain

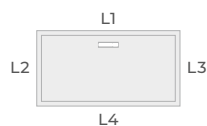

SCARICO CENTRALE  
Central Drain

Bordo nella stessa finitura del piatto doccia.

Realizzabile solo sui lati dritti (specificare quali)

*Edge in the same finish as the shower tray.*

*Available only on straight sides (please specify which ones)*

prezzo al cm/l  
*price per cm/l*

MAB0R01

## KIT DI RIPRISTINO

### Restoration kit



Kit per il ripristino di scheggiature.

Il kit comprende: catalizzatore, colore, scotch-brite, istruzioni

*Chip repair kit.*

*The kit includes: catalyst, color, Scotch-Brite, instructions.*

WKT0001

Kit per il ripristino di graffi superficiali.

Il kit comprende: boccetta colore, scotch-brite, istruzioni

*Surface scratch repair kit.*

*The kit includes: color bottle, Scotch-Brite, instructions.*

WKT0002