

FORME DISPONIBILI

Available Shapes

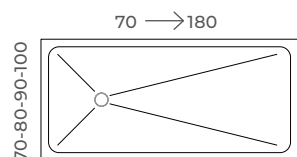

ALTEZZA

Height

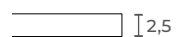

2,5 cm senza bordo
2,5 cm without edge

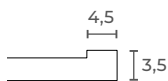

3,5 cm con bordo
3,5 cm with edge

INSTALLAZIONE

Installation



Sopra pavimento
Above floor



Filo pavimento
Flush with floor

COPRI PILETTA

Drain Cover

Disponibile solo materica in tinta
Available only in matching textured finish



MATERIALE

Material

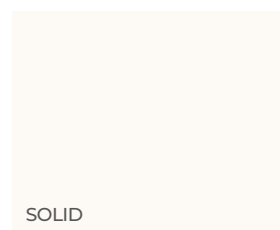

FINITURA SUPERFICIALE

Surface Finish

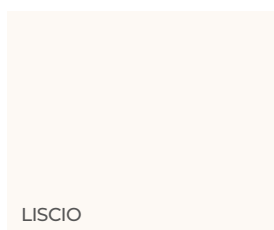

COLORAZIONI

Colors

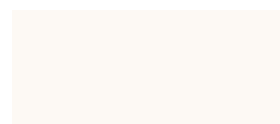

PIETRE

Stones

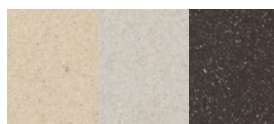

SCARICO LATERALE Lateral Drain

Disponibile in finitura Liscio
Available in Liscio finish

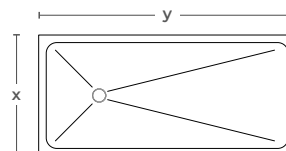

cm	x	70		80		90		100	
		LISCIO		LISCIO		LISCIO		LISCIO	
y		Bianco	Grit Stone	Bianco	Grit Stone	Bianco	Grit Stone	Bianco	Grit Stone
70		VEN0001	VEN0030	-	-	-	-	-	-
80		-	-	VEN0009	VEN0038	-	-	-	-
90		VEN0002	VEN0031	VEN0010	VEN0039	VEN0017	VEN0046	-	-
100		VEN0003	VEN0032	VEN0011	VEN0040	VEN0018	VEN0047	VEN0024	VEN0053
120		VEN0004	VEN0033	VEN0012	VEN0041	VEN0019	VEN0048	VEN0025	VEN0054
140		VEN0005	VEN0034	VEN0013	VEN0042	VEN0020	VEN0049	VEN0026	VEN0055
160		VEN0006	VEN0035	VEN0014	VEN0043	VEN0021	VEN0050	VEN0027	VEN0056
170		VEN0007	VEN0036	VEN0015	VEN0044	VEN0022	VEN0051	VEN0028	VEN0057
180		VEN0008	VEN0037	VEN0016	VEN0045	VEN0023	VEN0052	VEN0029	VEN0058



Scarica i disegni tecnici + schema taglio
in cantiere di tutti i formati disponibili
Download the technical drawings + cutting scheme
on-site for all available formats.

INFORMAZIONI TECNICHE

Technical Information

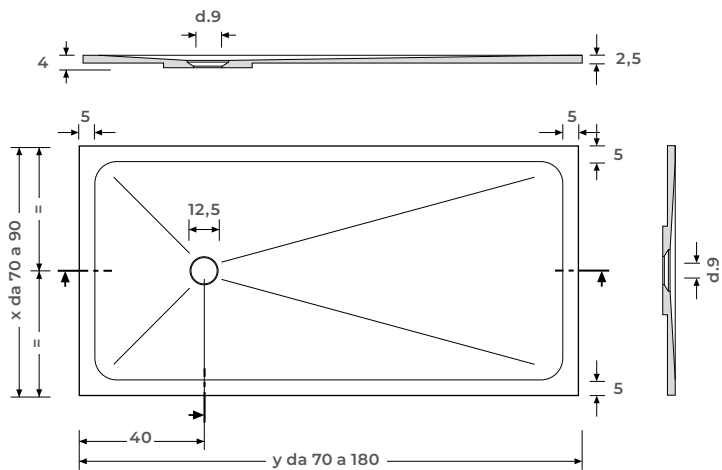

SCARICO LATERALE
Lateral Drain

COPRI PILETTA

Drain Cover



Disponibile solo materica in tinta con il piatto
Available only in matching textured finish with the tray

INCLUSA
included
WGR0022

PILETTE DI SCARICO

Drain Outlet

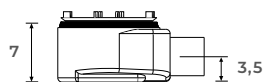

Piletta a scarico orizzontale D.90 (deflusso 25 lt/min)
Horizontal drain D.90 (flow rate 25 l/min)

INCLUSA
included
WPL0006

TAGLI A MISURA

Custom Cuts

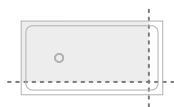

Taglio longitudinale ogni 5mm in larghezza o lunghezza (su uno o più lati)
 NOTA: il costo si intende per lato
Longitudinal Cut Every 5mm in Width or Length (on one or more sides)
 NOTE: The cost is per side

MTL0M01

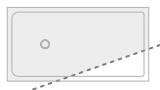

Taglio obliquo (su uno o più lati)
 NOTA: il costo si intende per ogni taglio
Diagonal Cut (on one or more sides)
 NOTE: The cost is per cut

MT0BL01



Taglio sagomato (su uno più angoli)
 NOTA: il costo si intende per ogni taglio
Shaped Cut (on one or more corners)
 NOTE: The cost is per cut

MTSAG01

Usfruendo delle soprascritte lavorazioni, il lato oggetto di modifica, verrà fornito con il bordo completamente ricostruito e texturizzato come la superficie del piatto doccia. Specificare la tipologia di taglio ed inviare disegno quotato. In base alla fattibilità il nostro ufficio commerciale si riserva l'accettazione dell'ordine.
By utilizing the above-mentioned modifications, the altered side will be provided with a fully reconstructed and textured edge, matching the surface of the shower tray. Please specify the type of cut and submit a detailed drawing with measurements. Based on feasibility, our sales office reserves the right to accept the order.

PERIMETRO OPZIONALE

Optional Perimeter



SCARICO LATERALE
 Lateral Drain

Bordo nella stessa finitura del piatto doccia.
 Realizzabile solo sui lati dritti (specificare quali)
Edge in the same finish as the shower tray.
 Available only on straight sides (please specify which ones)

prezzo al cm/l
 price per cm/l

MAB0R01

KIT DI RIPRISTINO

Restoration kit



Kit per il ripristino di scheggiature.
 Il kit comprende: catalizzatore, massa solid, scotch-brite, istruzioni
Chip repair kit.
 The kit includes: catalyst, massa solid, Scotch-Brite, instructions.

WKT0003

Kit per il ripristino di graffi superficiali.
 Il kit comprende: scotch-brite, istruzioni
Surface scratch repair kit.
 The kit includes: Scotch-Brite, instructions.

WKT0004